

FLOE BUMPER CAP & VINYL REPLACEMENT

ASSEMBLY INSTRUCTIONS

KIT P/N 510-03100-00 (30")

KIT P/N 510-03101-00 (40")



Kit Includes:

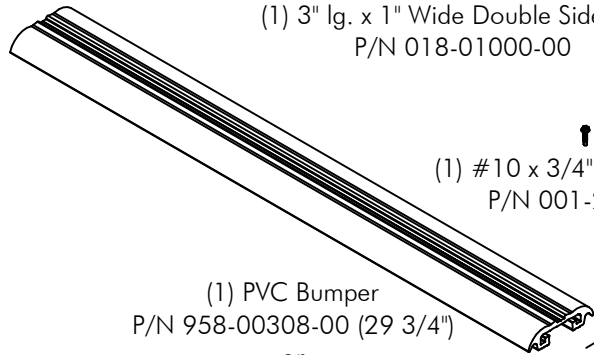
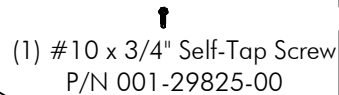
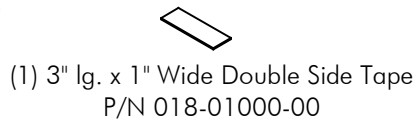
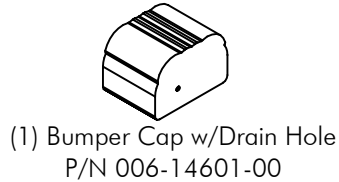
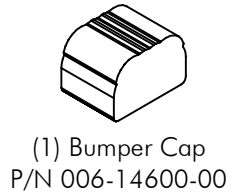

1. Remove caps and screw or Drill out rivets on existing PVC bumper using a #9 drill bit. Remove the PVC by sliding off the end of the bumper.
2. Slide the new PVC on the bumper so neither end extends past the end of the bumper.

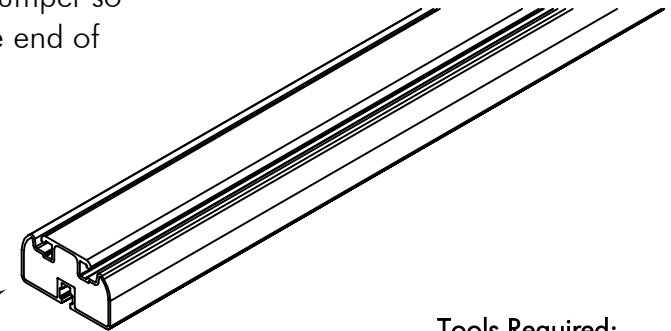

- Tools Required:
- #2 Square Drive Bit
 - #9 Drill Bit
 - Cordless Drill
 - Isopropyl Alcohol & Rag

4. Slide the bumper caps over the bumper extrusion. Top cap: Pull the edge of the cap out and over the tape. Pull the cap all the way on and make sure it adheres to the tape. Bottom cap: The cap with the drain hole should be installed on the bottom end of the bumper with screw 1/2" up from edge and centered.

3. Clean the outside of the aluminum bumper with alcohol where the caps will be installed. Cut double sided tape into (2) 1-1/2" long pieces and attach to the sides of the bumpers on top 1-1/2" from the ends as shown below.

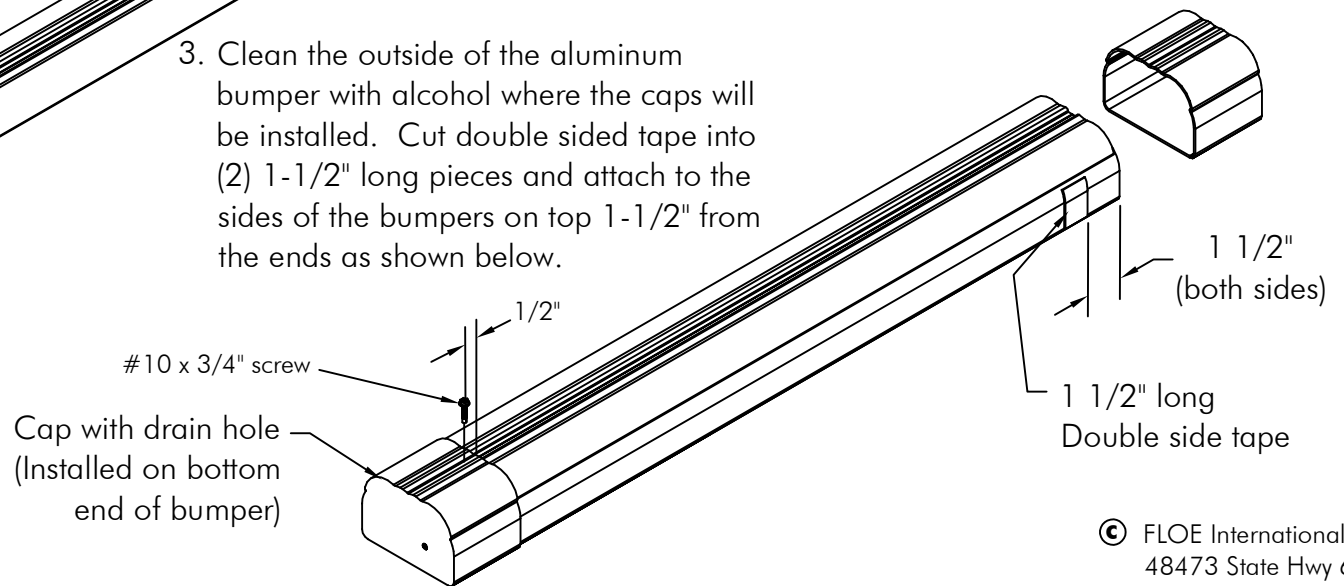

© FLOE International, Inc.
48473 State Hwy 65
McGregor, MN 55760
All rights reserved