

FLOE 24 VOLT VSD DRIVE 3800, 5000, 6000, 6500 & 8000# LIFTS

P/Ns 511-38500-01, 511-60020-01, 511-80025-01
ASSEMBLY INSTRUCTIONS



TOOLS REQUIRED:

- (2) 3/4" socket or wrench for 1/2" nuts and bolts
- (1) 9/16" socket or wrench for 3/8" nuts and bolts
- (1) Flat tip screwdriver
- (1) Torque wrench



INSTRUCTION P/N: 611-50025-01
ISSUE DATE: 8/18 REVISED: 3/21

Manufactured By:
Floe International, Inc.
48473 State Hwy. 65
McGregor, MN 55760

PARTS LIST

- (1) Two – Battery Box w/Volt Meter, Cover & Strap, 111-00461-00
- (2) One – Packet of Anti-Seize, 006-04000-00
- (3) One – VSD Tool Kit
 - One – Tool Kit Pouch, 007-03980-00
 - One – 3/8" Drive Socket Adapter, 007-03981-00
 - One – Grease Gun Adapter, 007-03982-00
 - One – VSD Limit Switch Test Plug, 007-05293-00
 - One – 5/16" Nut Setter, 007-03985-00
- (4) One – Diagnostic Checklist, 007-05305-00
- (5) 3.3 yards. – Double Sided Velcro, 014-02310-00
- (6) Two – Battery Tray weldments, 111-00014-00
- (7) One – Wired Remote, 111-70010-00
- (8) One – Battery Interconnect with Circuit Breaker,
 - 111-70015-00 included with 511-38500-01
 - 111-70017-00 included with 511-60020-01, 511-80025-01
- (9) One – Controller, Lift/Maxis 24V ASC, 311-50040-01
- (10) One - 24 Volt DC Drive Motor
 - 511-45018-01 included with 511-38500-01
 - 511-60025-01 included with 511-60020-01
 - 511-80025-01 included with 511-80025-01
- (11) One – 24 Volt DC Installation Instructions, 611-50025-01

Please refer to Page 3 for a visual reference of parts.



STEP 1 - - - - -

With the lift frame assembly done the VSD Drive Train and electronics can now be installed. Apply a generous amount of anti-seize to the inside of the rigid coupler (Fig. 1A). Then attach the "VSD Power Unit" to the "ball screw clamp" using four 3/8" x 1 3/4" bolts, four nylock nuts, and eight flat washers as shown (Fig 1B). Torque to 10 ft/lbs. NOTE: The motor shaft and the rigid coupler are keyed and must be aligned.

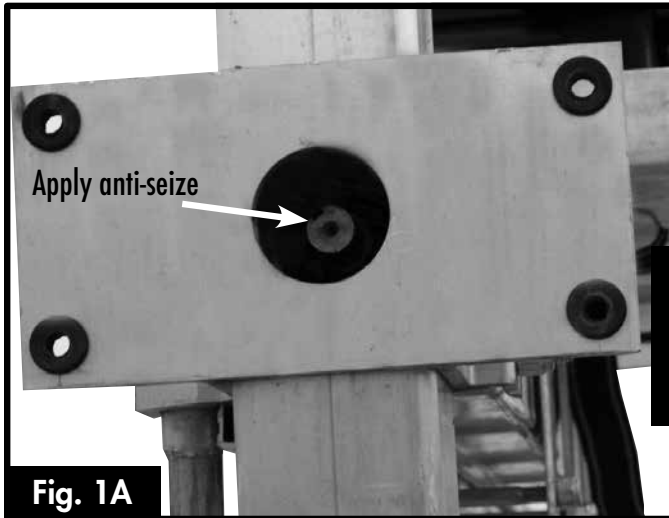

- - - - - **IMPORTANT** - - - - -
Apply a generous amount of Anti-Seize to the inside of the rigid coupler attached to the Ball Screw.

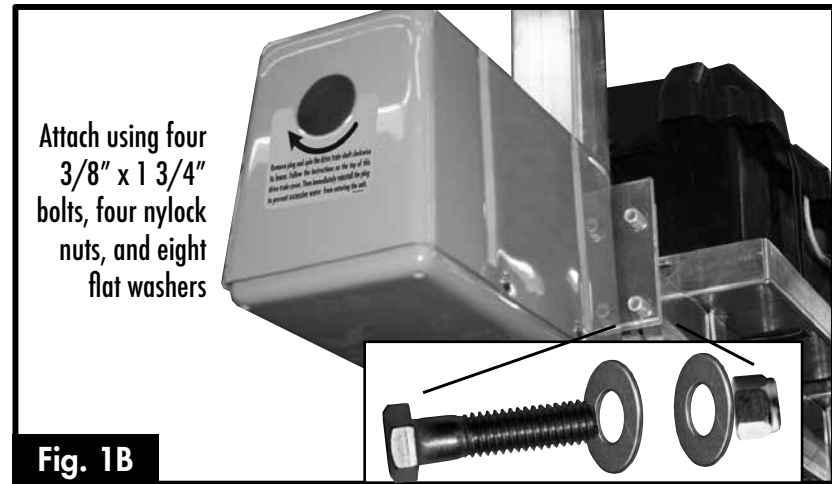

STEP 2 - - - - -

Attach the battery trays to the ball screw tube. The first one 8" from the corner post and the second 3" from the first using the (4) 3/8 x 5 -1/2" bolts and (4) 3/8" nylock nuts included with the lift frame hardware. The offset side of the battery tray should be positioned to the outside of the lift to provide clearance inside the lift. (Fig. 2) Torque to 25 ft/lbs.



STEP 3 - - - - -

Clean and adhere the dual lock 5-1/4" down from the top of the corner post. (Fig. 3A) Attach the Advanced Switch Control (ASC) to the hole in the top of the corner post with the nut, bolt, and washer provided. (Fig. 3B) Connect "Advanced Switch Control" to the "VSD Power Unit" by removing the four screws in the bottom cover. Inside the power unit is four wires with spade connectors. Connect these four wires with spade ends to the wires on the Advanced Switch Control (ASC) with the corresponding ends (Fig. 3C). The two small gauge wires on the ASC have female spade connectors and it does not matter to which small gauge on the VSD power unit that they connect to. The larger two wires have one male and one female connector so they cannot be incorrectly wired. Replace the cover on the bottom of the VSD Power Unit.

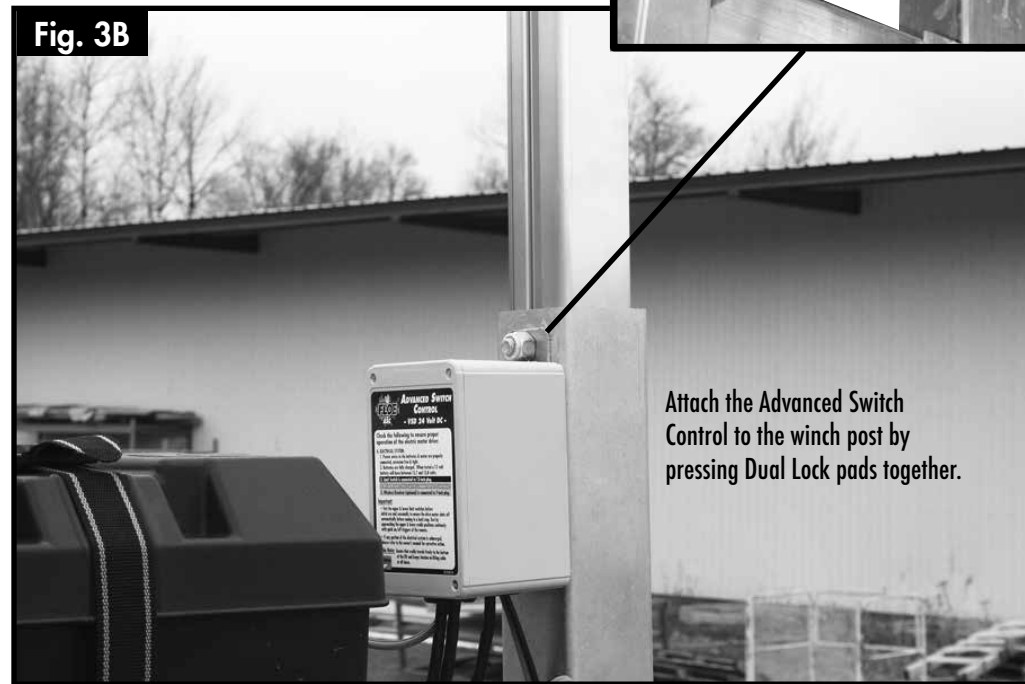
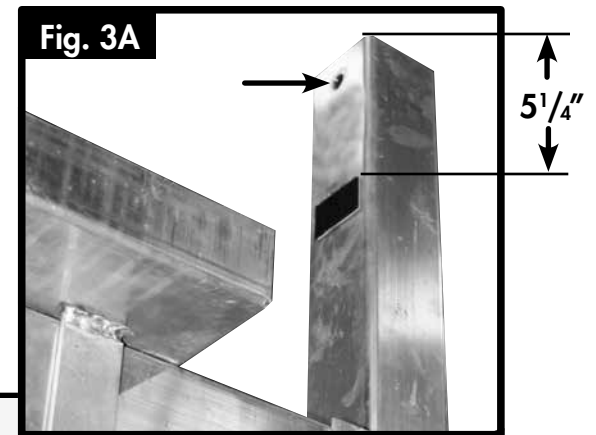

Attach the Advanced Switch Control to the winch post by pressing Dual Lock pads together.



STEP 4 - - - - -

Connect the two remaining wires coming out of the Advanced Switch Control (ASC) box to the batteries. The two wires on the Advanced Switch Control have ring connectors. One ring connector is red and the other is black and red. Connect these wires using the diagram (Fig. 4A). Connect the red wire to the positive post on the second battery and the black/red wire to the negative post on the first battery. Connect the Battery Interconnect cable between the two batteries use the diagram (Fig. 4A) as a reference. Also at this time attach the Battery Volt Meter leads (red to Positive and black to negative) of each battery. Example (Fig. 4B). Place the diagnostic Check List in the battery box for future reference. Replace the battery box covers and secure them with the strap.

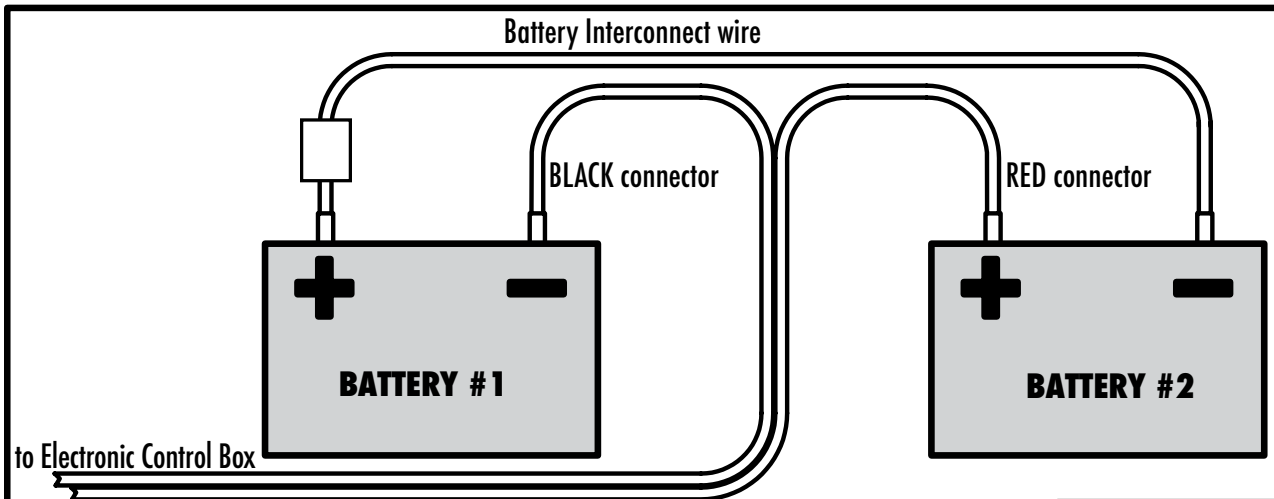

Fig. 4A



Fig. 4B

STEP 5 - - - - -

Plug 4 connector wired remote into the corresponding lead of the Advanced System Control box. Note: The wired remote lead is identified by the blue wire tie next to the base of the plug on the ASC as shown. Plug the 4 connector limit switch lead protruding from the bottom of the limit switch housing to the corresponding plug on the ASC.

NOTE: The two molex plugs are for the actuators on a Maxis tilting canopy. Refer to Maxis tilt instructions for proper assembly.

NOTE: The ASC Limit switch plug does not have a color coded cable tie attached. (Fig. 5A) Attach the adhesive-backed tool kit to the lift frame, so that these tools are readily available when needed, by cleaning the area above the tool kit decal and removing the protective backing and pressing it to the corner post as shown in (Fig. 5B).

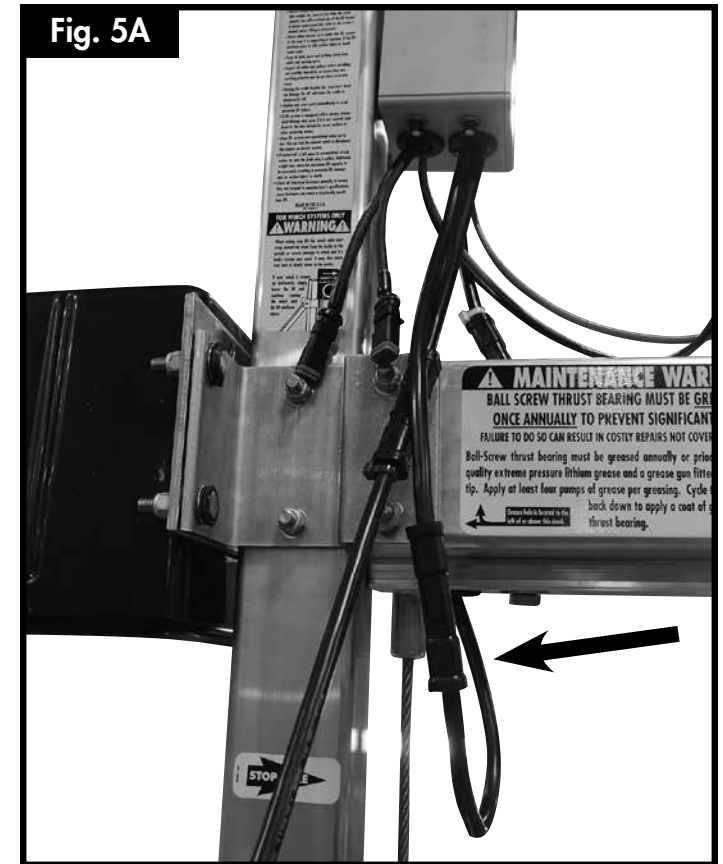

STEP 6 - - - - -

Secure all loose wires and the wire from the wired remote to the lift structure by cutting off pieces of the included double sided Velcro. The best way to secure the wired remote is to go up from the Advanced Switch Control and attach the wire to the inside of the canopy frame if you have one. Then come down from the canopy frame to the side of your lift that is against the dock. (Fig. 6A) and (Fig. 6B)

