

CARPETED GUIDE IN SYSTEMS

VSD 6000-7500

ASSEMBLY INSTRUCTIONS

P/N 511-02583-00

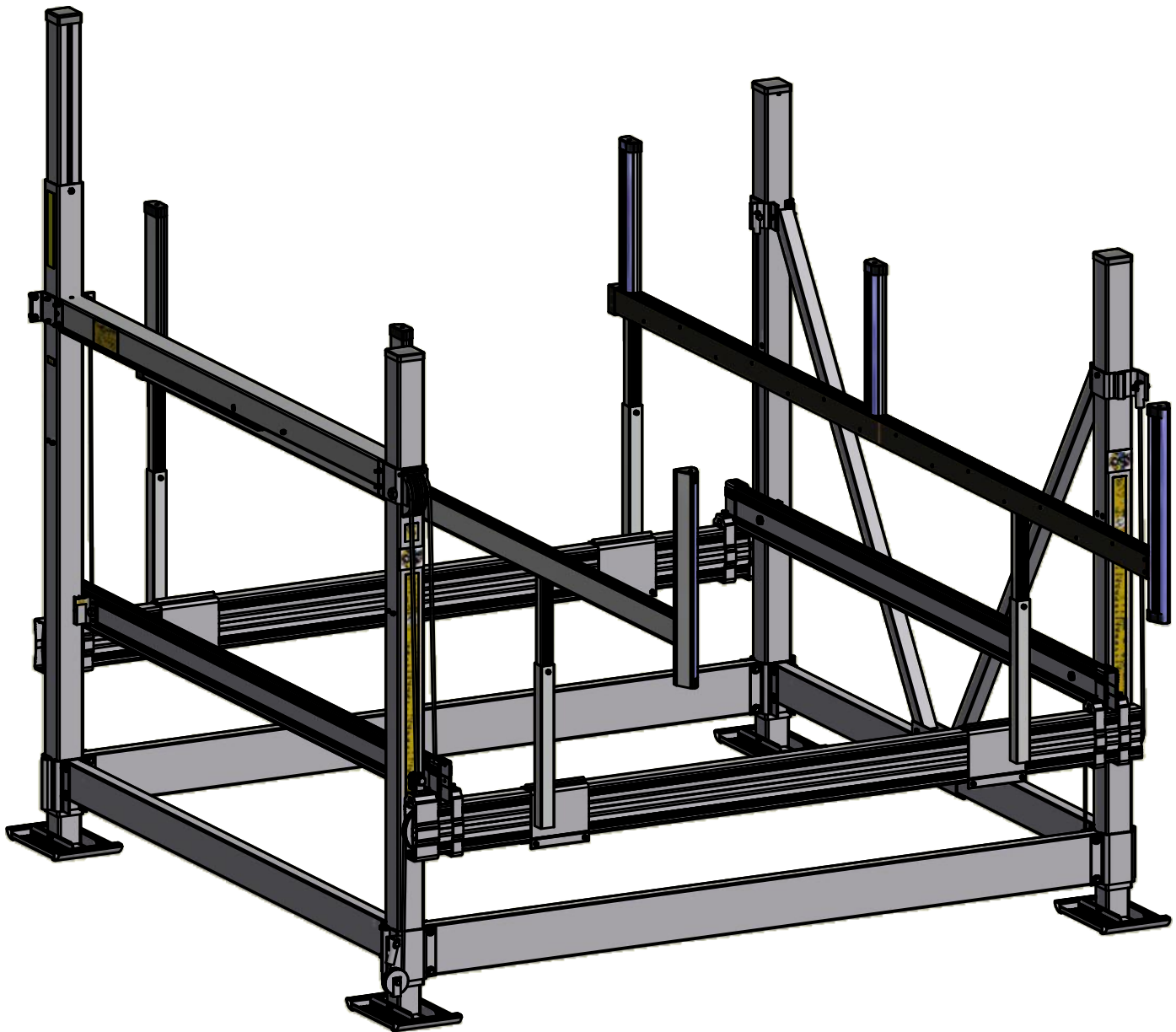

TOOLS REQUIRED

- (2) 9/16" Socket or Wrench
- Torque Wrench

CARPETED GUIDE IN SYSTEMS

VSD 6000-7500

EXPLODED VIEW AND BOM

P/N 511-02583-00

ITEM	QTY	PART NUMBER	DESCRIPTION
1	8	001-70114-00	HHCS, 3/8-16 x 2 3/4" SS
2	8	001-70119-00	HHCS, 3/8-16 x 4" SS
3	16	001-76071-00	Nut, Nylock 3/8-16 Alum.
4	1	111-02557-00	ASS'Y, CARPET GUIDE (RIGHT)
5	1	111-02558-00	ASS'Y, CARPET GUIDE (LEFT)
6	2	111-02501-00	ASS'Y, GUIDE CLAMP
7	2	111-02502-00	ASS'Y, GUIDE CLAMP
8	1	511-75075-00	LIFT, VSD-7500 FRAME

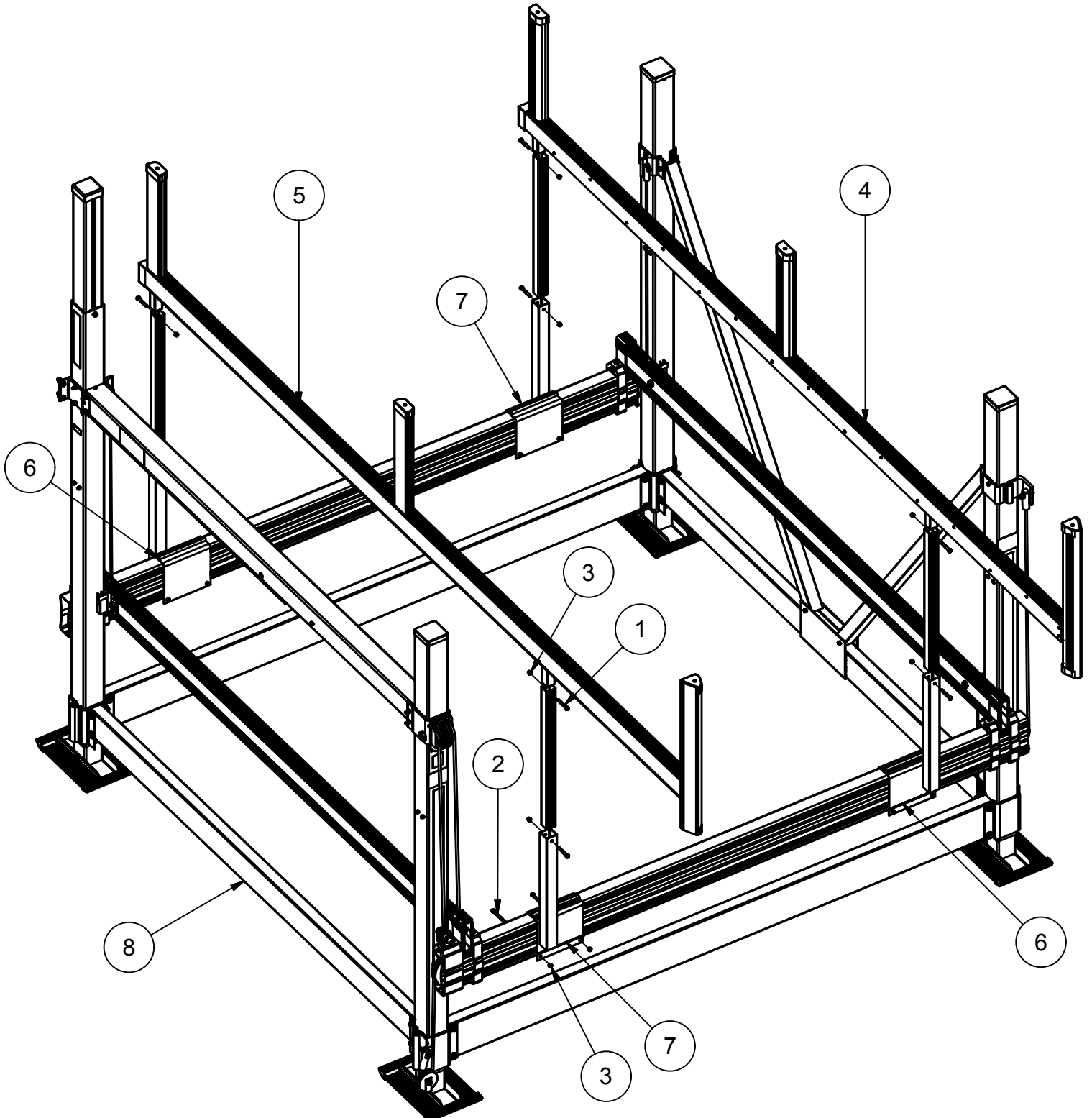

STEP 1

- Before attaching the G.I. Clamps to the cradle beam, slide the clamps together so the ends are flush with each other. See Fig. 1

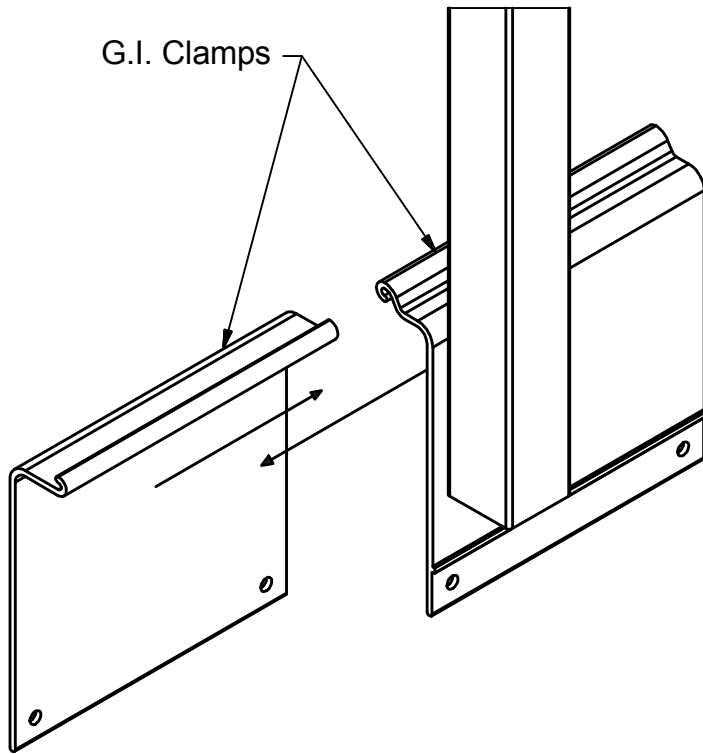

FIG. 1

STEP 2

- Attach the clamp assembly onto the cradle beam using the 3/8 x 4" bolts and nuts. See Fig. 2. Refer to Exploded View on Sheet 2 for orientation when placing on cradle beams. Once you have placed the clamps in their final location, torque bolts to 35 ft. lbs.

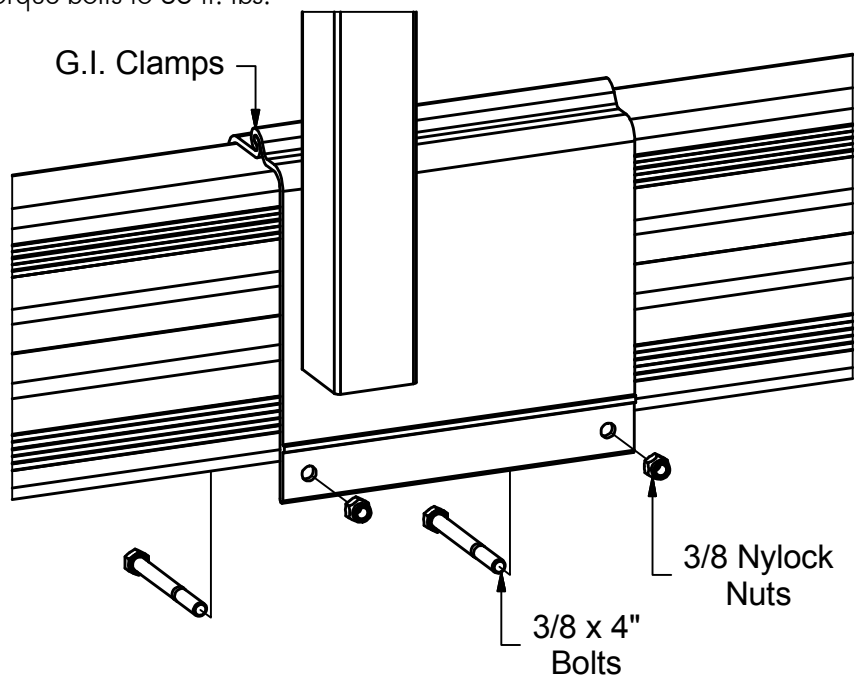
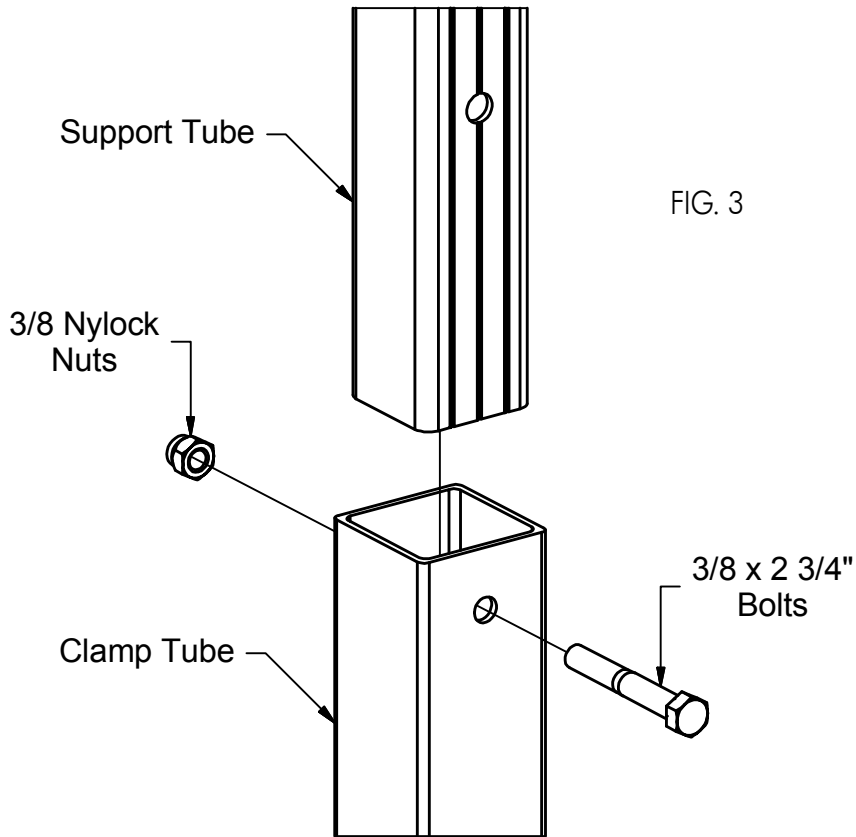

FIG. 2

STEP 3

- Insert the Support Tubes into the Clamp Tubes and tighten with 3/8 x 2 3/4" bolts and nuts. Torque to 50 ft. lbs. See Fig. 3



STEP 4

- Place the Guide Ins into the Support Tubes and fasten in place using the 3/8 x 2 3/4" bolts and nuts. Torque to 35 ft. lbs. See Fig. 4

