

# CARPETED GUIDE IN SYSTEMS W/BUMPER

## ASSEMBLY INSTRUCTIONS

P/N 511-02580-00

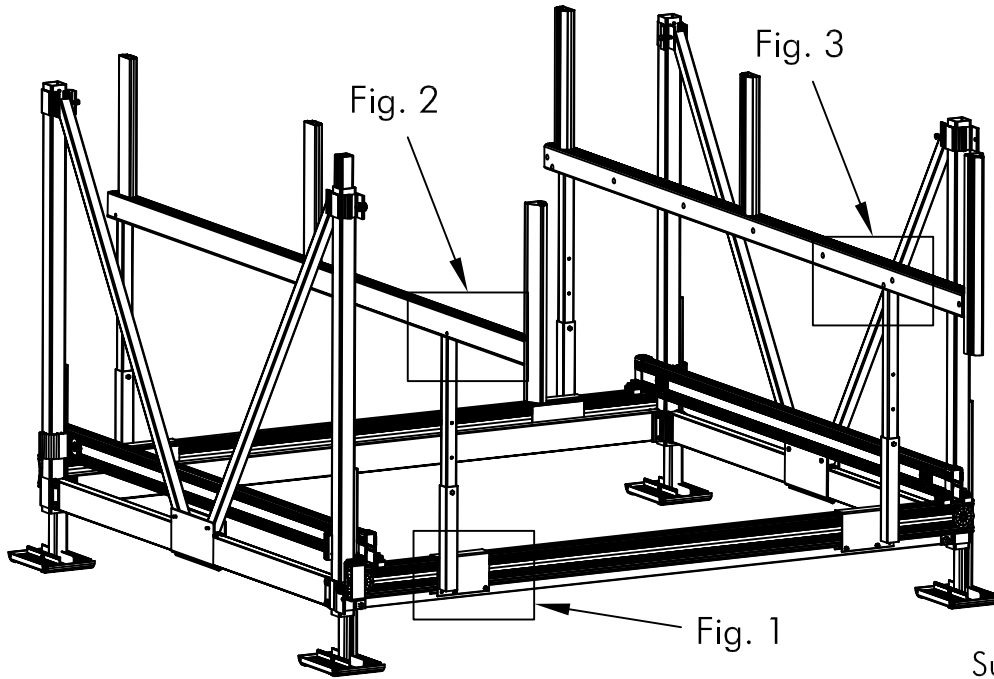

1. Attach the tube clamp bracket to the cradle beam using the 3/8" x 3" bolts and nuts. See Fig. 1. Once you have placed the brackets in their final location, torque bolts to 35 ft. lbs.

2. Insert Support Tubes into U-Clamp Tubes and tighten with 3/8" x 2 3/4" bolts and nuts. Torque to 50 ft. lbs.

3. Place the bunks over the tubes with the thru bolts to the outside of the tubes. See Fig. 3. Torque to 35 ft. lbs.

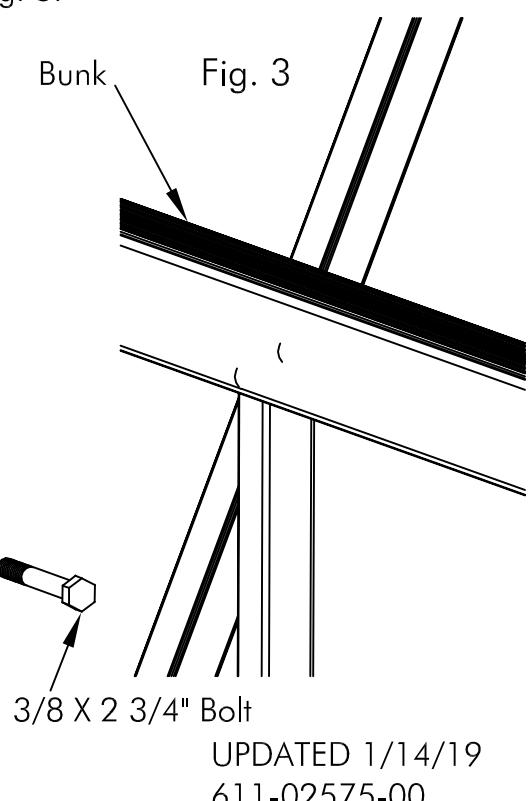
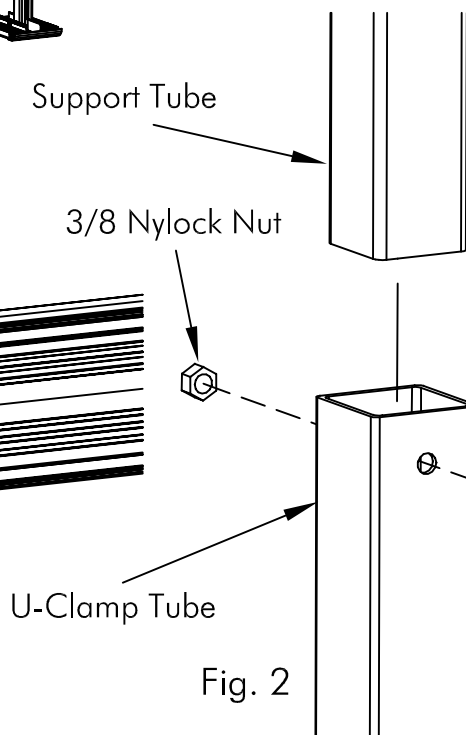
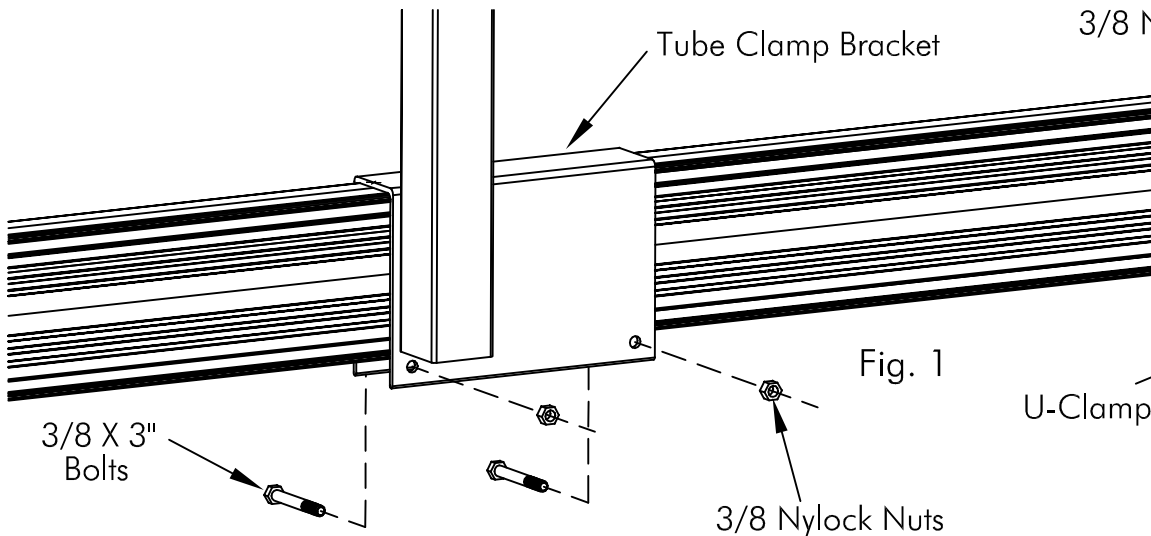

UPDATED 1/14/19  
611-02575-00