



# PADDLE BOARD & KAYAK RACK ASSEMBLY INSTRUCTIONS P/N 610-41550-00

## PADDLE BOARD & KAYAK RACK INSTALLATION

PLEASE RETAIN THIS INSTRUCTION MANUAL FOR FUTURE REFERENCE

### TOOLS REQUIRED:

- 9/16" SOCKET OR WRENCH
- 13/32" DRILL BIT
- CENTER PUNCH
- CORDLESS DRILL
- FRAMING SQUARE
- HAMMER
- TAPE MEASURE
- TORQUE WRENCH

**NOTE: READ THESE INSTRUCTIONS CAREFULLY AND COMPLETELY AND UNDERSTAND ALL ASSEMBLY AND ADJUSTMENT PROCEDURES PRIOR TO PERFORMING THE INSTALLATION AND MAKING ANY ADJUSTMENTS.**

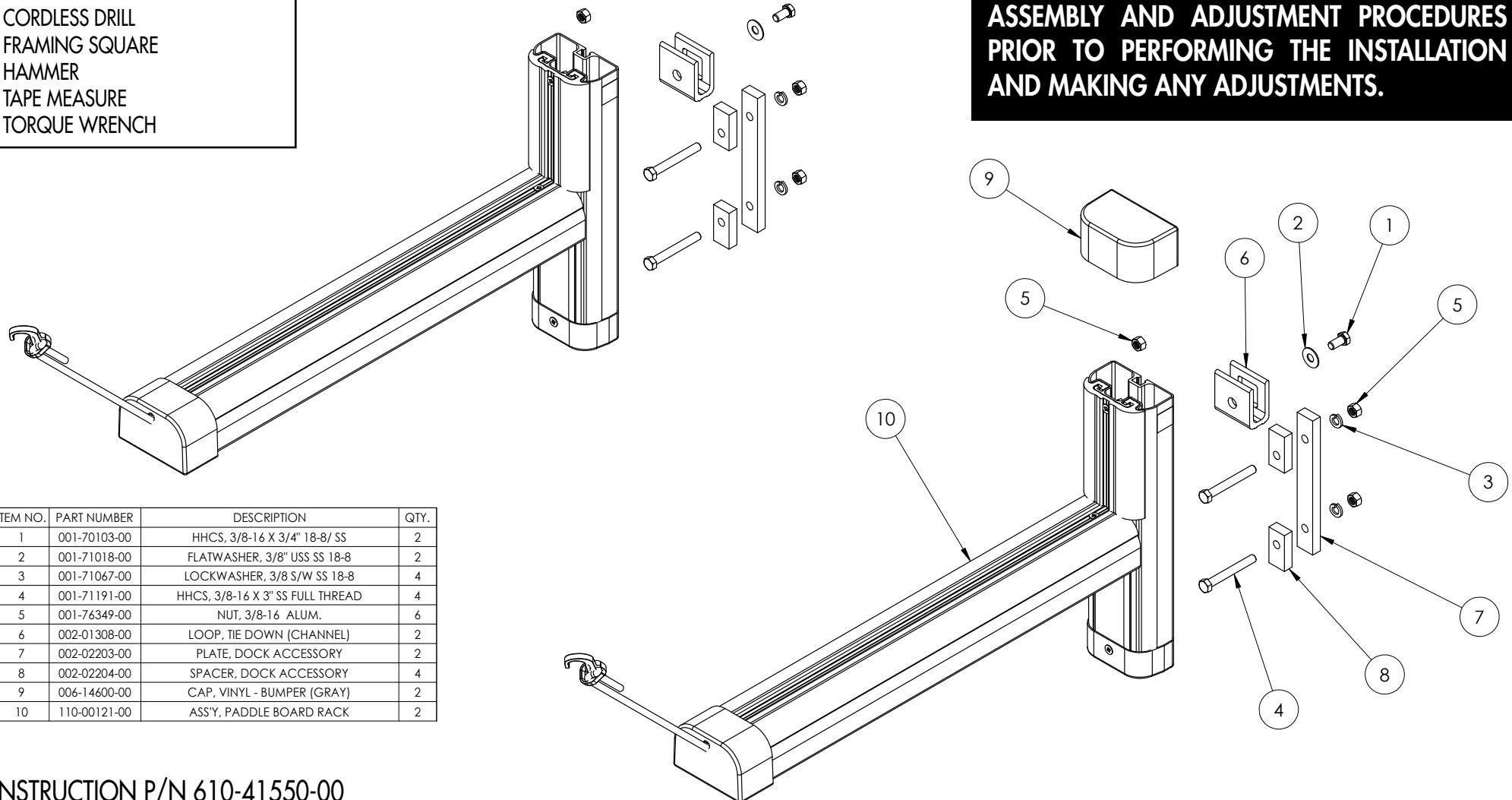

ITEM NO.	PART NUMBER	DESCRIPTION	QTY.
1	001-70103-00	HHCS, 3/8-16 X 3/4" 18-8/ SS	2
2	001-71018-00	FLATWASHER, 3/8" USS SS 18-8	2
3	001-71067-00	LOCKWASHER, 3/8 S/W SS 18-8	4
4	001-71191-00	HHCS, 3/8-16 X 3" SS FULL THREAD	4
5	001-76349-00	NUT, 3/8-16 ALUM.	6
6	002-01308-00	LOOP, TIE DOWN (CHANNEL)	2
7	002-02203-00	PLATE, DOCK ACCESSORY	2
8	002-02204-00	SPACER, DOCK ACCESSORY	4
9	006-14600-00	CAP, VINYL - BUMPER (GRAY)	2
10	110-00121-00	ASS'Y, PADDLE BOARD RACK	2

# PRE-MOUNTING SETUP



FIG. A

1. INSERT (2) 3/8 X 3 BOLTS INTO THE NUT TRACK FROM THE TOP (FIG. A)

2. ATTACH THE SHOCK CORD BRACKET TO THE BACK OF THE RACK BY INSERTING (1) 3/8" ALUM NUT INTO THE NUT TRACK (FIG. B).

3. PLACE A 3/8" FLAT WASHER ON THE 3/8" X 3/4" BOLT AND INSERT INTO SHOCK CORD BRACKET (FIG. C).

4. THREAD BOLT INTO NUT FROM STEP #2 AND RE-POSITION SO THAT OPEN END OF BRACKET FACES TOWARD TOP. SLIDE BRACKET 3" FROM TOP EDGE (FIG. D) AND TORQUE TO 35 FT/LBS.

5. PEEL OFF PROTECTIVE BACKING FROM THE DOUBLE STICK TAPE ON EACH SIDE AND SLIDE VINYL CAP OVER END (FIG. E & FIG. F).

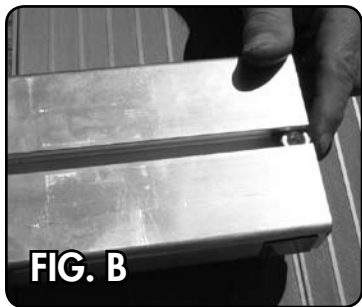

FIG. B

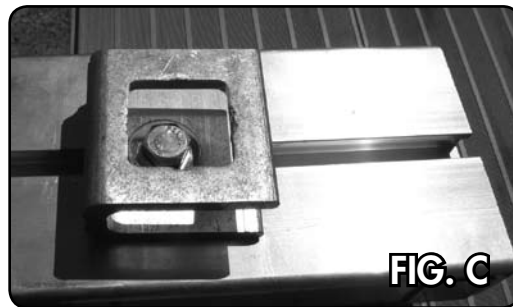

FIG. C

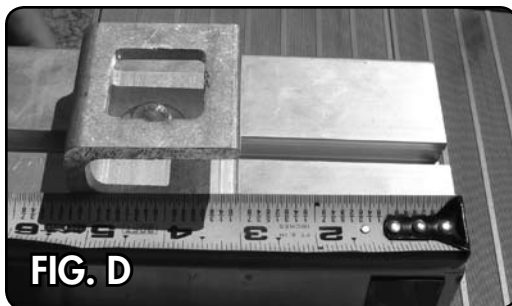

FIG. D

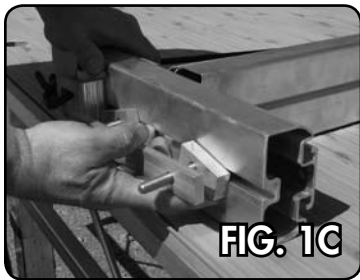

FIG. E



FIG. F

## ROLL-IN DOCKS



1. DETERMINE THE LOCATION OF THE PADDLE BOARD/KAYAK RACK. ONCE THE DESIRED LOCATION IS ESTABLISHED, MOUNT THE FIRST BRACKET ASSEMBLY BY INSERTING (2) 3/8 X 3" BOLTS INTO THE NUT TRACK FROM THE BOTTOM AND PLACE THEM BETWEEN THE UPPER AND LOWER TUBES OF THE DOCK FRAME (FIG. 1A). PLACE A DOCK ACCESSORY SPACER ON EACH BOLT IF NECESSARY (FIG. 1B) (SEE NOTE BELOW) AND (1) DOCK ACCESSORY PLATE ON THE BOLTS (FIG. 1C) AND ATTACH WITH (2) 3/8" LOCK WASHERS AND (2) 3/8" ALUMINUM NUTS (FIG. 1D). ADJUST THE HEIGHT SO THE SHOCK CORD BRACKET IS 5/8" ABOVE THE DECKING (FIG. 1E).

**NOTE: IF THE BOLT IS CLOSE TO A WEB ON THE DOCK, DO NOT ADD A SPACER. THE WEBBING ACTS AS THE SPACER (FIG. 1F).**

2. DETERMINE THE LOCATION OF THE SECOND BRACKET ASSEMBLY. **NOTE: THE SECOND BRACKET SHOULD BE SPACED FAR ENOUGH APART SO THAT THE EDGE OF THE PADDLE BOARD/KAYAK RACK DOESN'T EXTEND OVER THE SIDE OF THE DOCK. THE DISTANCE BETWEEN THE BRACKETS WILL VARY DUE TO VAST ARRAY OF PADDLE BOARDS AND KAYAKS ON THE MARKET. (SEE FIG. 2A & 2B)**

ATTACH THE SECOND BRACKET WITH (2) 3/8 X 3 BOLTS, (2) 3/8" LOCK WASHERS AT THE SAME HEIGHT AS THE FIRST. TORQUE TO 35 FT/LBS.



## SECTIONAL DOCKS

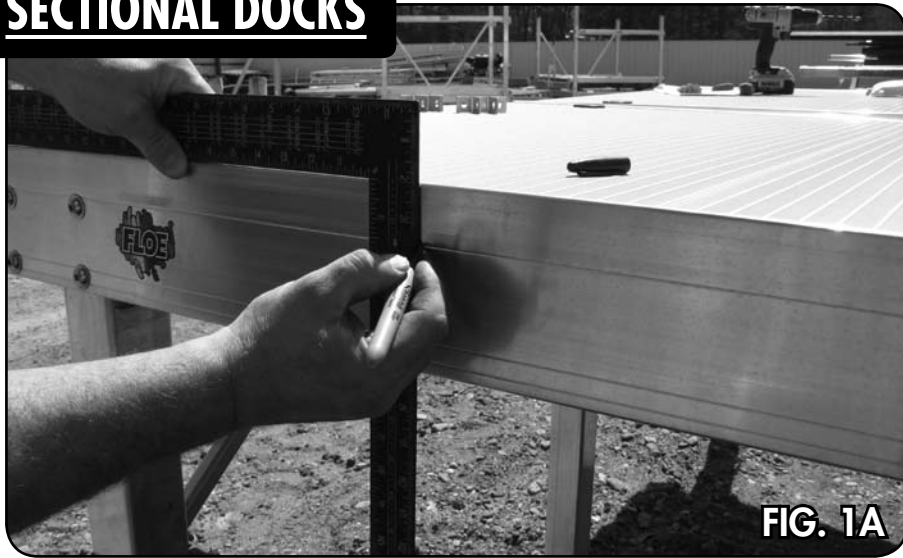

FIG. 1A



FIG. 1B



FIG. 2B



FIG. 1C

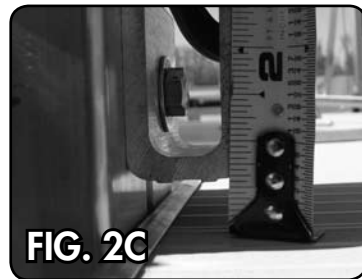

FIG. 2C



FIG. 2A

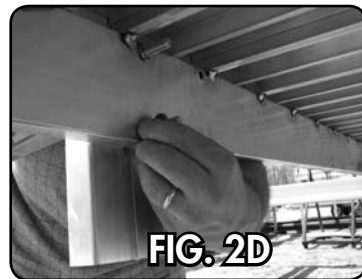

FIG. 2D

1. DETERMINE THE LOCATION OF THE FIRST PADDLE BOARD/KAYAK RACK. USING A FRAMING SQUARE MARK A VERTICAL LINE ACROSS THE TOP AND BOTTOM SERRATION (THESE SERRATIONS ARE 3" APART AND INTENDED TO ACT AS A HOLE SPACING REFERENCE) (FIG 1A). USE A HAMMER AND A CENTER PUNCH TO MAKE A DIMPLE FOR THE DRILL BIT (FIG 1B). THIS HELPS TO PREVENT THE DRILL FROM WANDERING DURING THE DRILLING OPERATION. KEEP THE DRILL PERPENDICULAR TO THE DOCK FRAME WHILE DRILLING. DRILL THROUGH BOTH WALLS OF THE DOCK FRAME (FIG 1C).

2. INSERT (2) 3/8 X 3" BOLTS IN INTO THE NUT TRACK FROM THE BOTTOM OF THE BRACKET (FIG. 2A) AND INSERT THE BOLTS THROUGH THE DRILLED HOLES IN THE DOCK FRAME (FIG. 2B) AND ADJUST THE HEIGHT SO THE SHOCK CORD BRACKET IS 5/8" ABOVE THE DECKING (FIG. 2C). ATTACH WITH (2) 3/8" LOCK WASHERS AND (2) 3/8" ALUMINUM NUTS (FIG. 2D). TORQUE TO 35 FT/LBS.

3. DETERMINE THE LOCATION OF THE SECOND BRACKET ASSEMBLY. **NOTE: THE SECOND BRACKET SHOULD BE SPACED FAR ENOUGH APART SO THAT THE EDGE OF THE PADDLE BOARD/KAYAK RACK DOESN'T EXTEND OVER THE SIDE OF THE DOCK. THE DISTANCE BETWEEN THE BRACKETS WILL VARY DUE TO VAST ARRAY OF PADDLE BOARDS AND KAYAKSON THE MARKET. (SEE FIG. 3A & 3B)**

ATTACH THE SECOND BRACKET WITH (2) 3/8 X 3 BOLTS, (2) 3/8" LOCK WASHERS AT THE SAME HEIGHT AS THE FIRST. TORQUE TO 35 FT/LBS.



FIG. 3A



FIG. 3B